

INTEX® OWNER'S MANUAL

Pool Volleyball Set for Intex® Oval Pools

IMPORTANT SAFETY RULES

Read, Understand and Follow All Instructions Carefully Before Installing and Using this Product.

⚠ WARNING

- POOL AND POOL ACCESSORIES ARE TO BE ASSEMBLED AND DISASSEMBLED BY ADULTS ONLY.
- USE ONLY UNDER COMPETENT SUPERVISION.
- WHEN NOT IN USE REMOVE FROM THE POOL AND STORE IN A SAFE PLACE INDOORS.
- DO NOT USE DURING WINDY AND GUSTY DAYS.
- FOLLOW THESE RULES TO AVOID SERIOUS INJURY OR PROPERTY DAMAGE.
- USE ONLY MANUFACTURER SUPPLIED BALLS. PROFESSIONAL ATHLETIC BALLS ARE NOT RECOMMENDED.
- YOU MUST FIRST SET UP AND FILL THE POOL WITH WATER FOLLOWING THE POOL OWNER'S MANUAL BEFORE INSTALLING.
- DO NOT CLIMB, HANG, PULL, PUSH OR GRAB ANY PART OF THE STRUCTURE. THE STRUCTURE IS NOT DESIGNED TO SUPPORT USER BODY WEIGHT.
- REMOVE THE STRUCTURE BEFORE PLACING A POOL COVER OVER THE POOL.

ALWAYS FOLLOW ALL SAFETY RULES. CARELESSNESS, OR LACK OF ATTENTION, CAN HAVE SERIOUS CONSEQUENCES, SUCH AS PARALYSIS OR OTHER PERMANENT INJURIES.

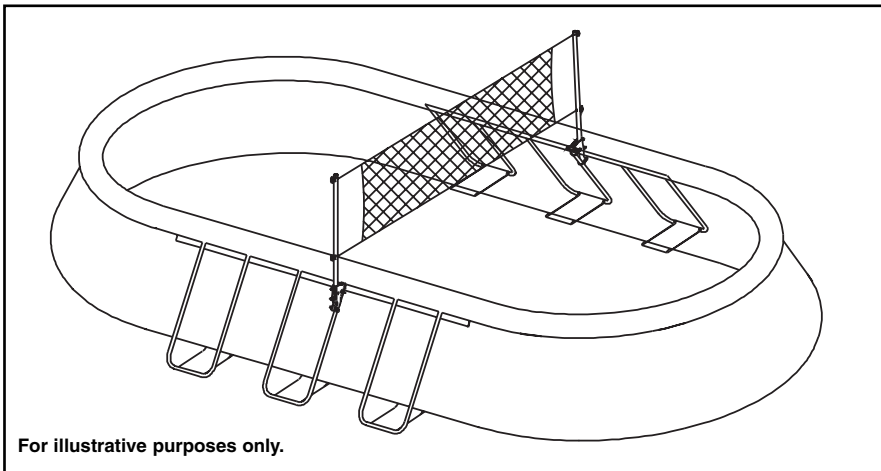

For illustrative purposes only.

SAVE THESE INSTRUCTIONS

PARTS LIST

1		2		3		4	
5		6		7		8	
9		10		11			

NOTE: Drawings for illustration purpose only. May not reflect actual product. Not to scale.

PARTS REFERENCE

Before assembling your product, please take a few minutes to check the contents and become familiar with all the parts.

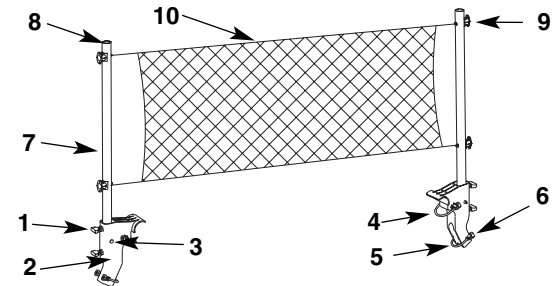

REF. NO.	DESCRIPTION	QTY.	SPARE PARTS NO.
1	CONTROL SCREW	4	10545
2	POLE BRACKET	2	10684
3	X-LONG PIN (WITH 2 EXTRA)	4	10110
4	U-BOLT A	2	10686
5	U-BOLT B	2	10544
6	NUT	8	10657
7	POLE	2	10685
8	VOLLEYBALL POLE END PLUG	2	10539
9	VOLLEYBALL NET FASTENER	4	10535
10	VOLLEYBALL NET	1	10866
11	VOLLEYBALL	1	10541

SAVE THESE INSTRUCTIONS

Set Up Instructions

IMPORTANT: Before proceeding to the next step ensure the pool is fully set up and filled with water following the pool owner's manual.

1. Attach a Pole Bracket (2), a U-Bolt (5) and a U-Bolt A (4) to the oval pool center "U-shape" leg along the length of the pool. Make sure the Pole Bracket (2) is securely attached to the "U-shape" leg.

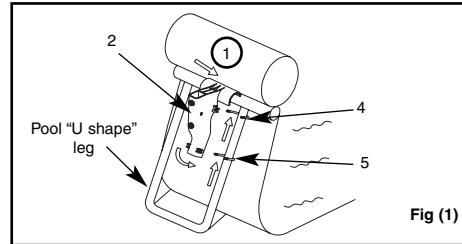

2. Secure the Pole Bracket (2) to the "U-shape" leg with the U-bolt (5), U-bolt A (4) and four Nuts (6).

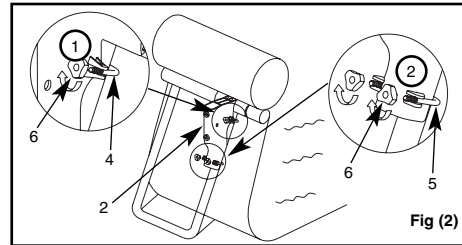

3. Attach two Volleyball Net Fasteners (9) to the Volleyball Pole (7). Ensure the Volleyball Net Fasteners (9) are facing outward.

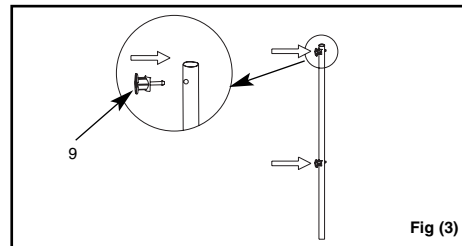

SAVE THESE INSTRUCTIONS

Set Up Instructions (cont.)

4. Insert the assembled volleyball pole into the Pole Bracket (2). Secure the pole to the bracket with a Long Pin (3). Clockwise screw in the two Control Screws (1) to adjust the pole vertically position.

NOTE: Adjust the pole inclination by adjusting the two Control Screws (1). Do not over tighten or use tool such as pliers.

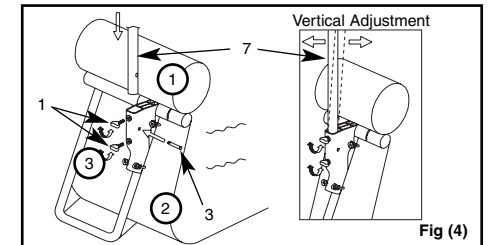

5. Locate the opposite "U-shape" leg and attach the second Pole Bracket (2) to the "U-shape" leg, repeat steps #1 to #4.

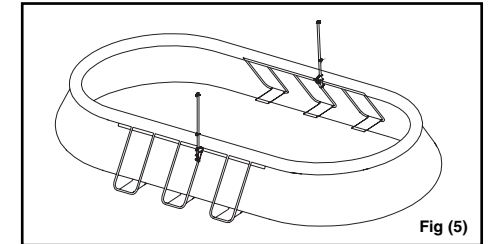

6. Attach one side of the Volleyball Net (10) starting from the top Volleyball Net Fastener (9) and then the bottom fastener. Loop the rope around the fastener (9) several times and secure the end of the rope to the two notches in the fastener. **NOTE:** Adjust the length of the rope to be looped around the fasteners depending on the size of the pool. Repeat this procedure for the other pole.

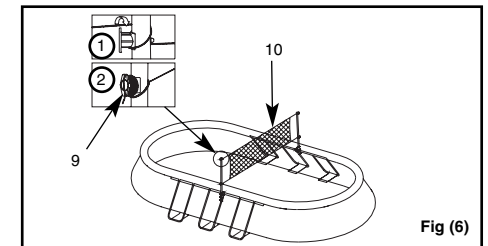

©2008 Intex Marketing Ltd. - Intex Development Co. Ltd. - Intex Trading Ltd. - Intex Recreation Corp. All rights reserved/Tous droits réservés/Todos los derechos reservados/Alle Rechte vorbehalten. Printed in China/Imprimé en Chine/Impreso en China/Gedruckt in China. ®™ Trademarks used in some countries of the world under license from®™ Marques utilisées dans certains pays sous licence de/Marcas registradas utilizadas en algunos países del mundo bajo licencia de/Warenzeichen verwendet in einigen Ländern der Welt in Lizenz von/Intex Marketing Ltd. to/a/an Intex Trading Ltd., Intex Development Co. Ltd., G.P.O Box 28829, Hong Kong & Intex Recreation Corp., P.O. Box 1440, Long Beach, CA 90801 • Distributed in the European Union by/Distribué dans l'Union Européenne par/Distribuido en la unión Europea por/Vertrieb in der Europäischen Union durch/Intex Trading B.V., P.O. Box nr. 1075 - 4700 BB Roosendaal - The Netherlands



SAVE THESE INSTRUCTIONS